

# ► Hydra-jet G03-1000



## Hydra-Jet

**HIGH PRESSURE COOLANT SYSTEM**

### MODEL G03-1000

- Volume 11 litres min
- Manually adjustable pressure setting 0-1000psi - 70 bar
- 1 M code controlled outlet
- Filtration 5-200 microns (customer to specify)
- Final filter vessel and standby filter
- Lift out changeable bag
- Din plug socket installation
- Small footprint

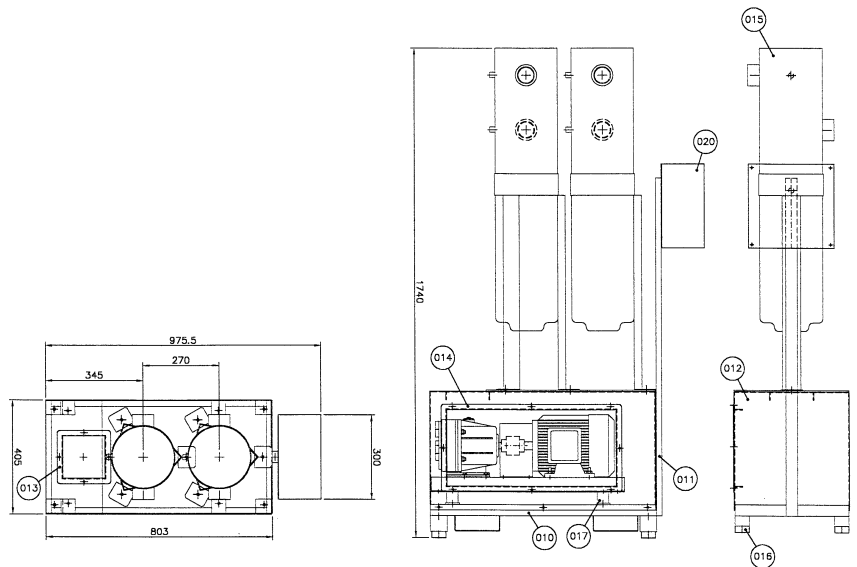

### EACH SYSTEM INCLUDES:

- 2 metres of high pressure hose from machine to our unit
- Flow sensing filter blocked alarm
- Easy change filter bags and filter change procedure
- Harting plug and socket interface
- Low pressure feed hose from machine to high pressure pre filters
- Low coolant alarm
- Oil change kit

### OPTION AVAILABLE:

- In line pressure sensor
- In line flow meter
- Hour running timer
- Warning beacons
- Warning alarms



6 Collins Road, Heathcote Industrial Estate, Warwick CV34 6TF United Kingdom.  
**telephone:** 01926 451744 **fax:** 01926 451284  
**e-mail:** sales@pumps-equip.co.uk **web:** www.pumps-equip.co.uk